



User's manual VM315/VM315-15/VM315-19

Accessory baby unit for use with VTech model VM345/VM345-15/VM345-19 /VM345-2



Congratulations

on purchasing your new VTech product. Before using this product, please read **Important safety instructions**.

This manual has instructions on how to set up and pair your new baby unit. For complete instructions on using the baby unit, see the user's manual that comes with your video and audio monitor.

For support, shopping, and everything new at VTech, visit our website at www.vtechphones.com.

Register online to get an additional 3-month warranty!

Visit www.vtechphones.com.

Registration
Register your product online for enhanced warranty support.

Product news
Learn about the latest VTech products.

What's in the box

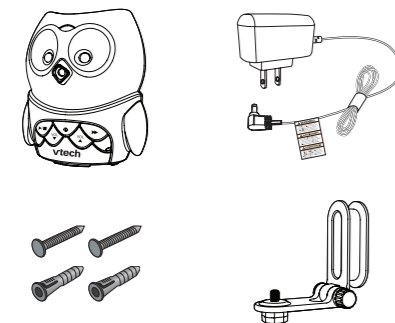

Connect the baby unit

NOTES

- Use only the power adapter supplied with this product.
- Make sure the electrical outlet is not controlled by a wall switch.
- The power adapter is intended to be correctly oriented in a vertical or floor mount position. The prongs are not designed to hold the plug in place if they are plugged into a ceiling, under-the-table or cabinet outlet.
- Make sure the baby unit and the power adapter cord are out of reach of children.

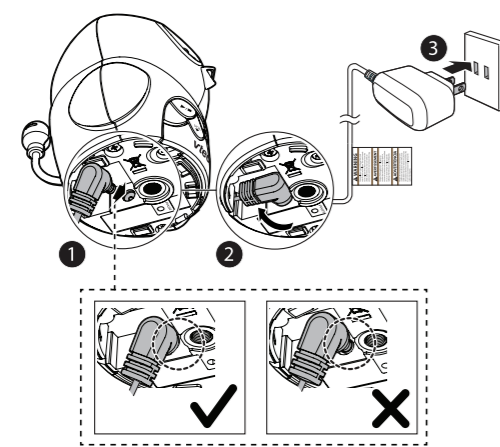

Overview

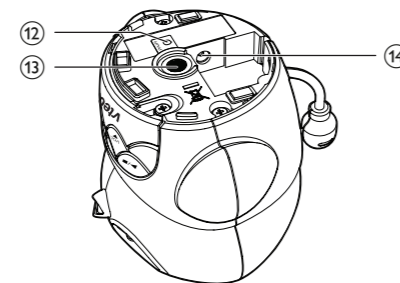
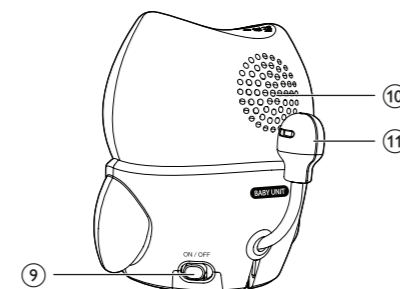
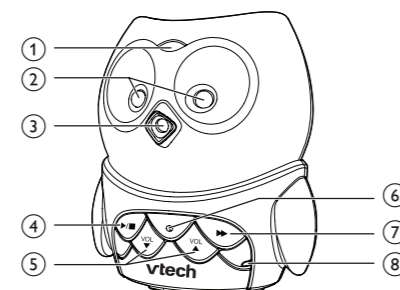

1	Light sensor
2	Infrared LEDs
3	Camera
4	▶/■ Play/Stop <ul style="list-style-type: none"> Press to play or stop lullaby on the baby unit.
5	▼/VOL/▲ <ul style="list-style-type: none"> Press to adjust the baby unit speaker volume. It determines the lullaby volume and talkback volume transmitted from the parent unit.
6	Microphone
7	▶▶ Skip <ul style="list-style-type: none"> Press to play the next lullaby.
8	ON/OFF light <ul style="list-style-type: none"> On when the baby unit is turned on and is paired to the parent unit. Flashes when the baby unit is not being viewed; or when the link to the parent unit is lost.
9	ON/OFF switch <ul style="list-style-type: none"> Slide to turn on or off the baby unit.
10	Speaker
11	Temperature sensor
12	PAIR <ul style="list-style-type: none"> Press and hold to pair to the parent unit.
13	Threaded socket <ul style="list-style-type: none"> For wall mount installation use.
14	Power jack

Before use

Pair new baby unit

Each newly purchased baby unit (VM315/VM315-15/VM315-19) must be paired to your video and audio monitor system (VM345/VM345-15/VM345-19/VM345-2).

NOTES

- You can pair a maximum of four baby units to your parent unit. Each new baby unit must be paired to the parent unit before use.
- Make sure you power on the parent unit before pairing.

- Press **MENU** when the parent unit is idle.
- Press ▼ or ▲ to choose **Pair/Unpair CAM**, then press **SELECT**.
- Press **SELECT** again to choose **Pair CAM**.
- Press ▼ or ▲ to choose an empty baby unit slot, then press **SELECT**.
- The parent unit screen displays **Press and hold the pair button at the CAM for 5 seconds until the power indicator flashes..** Immediately **press and hold PAIR** on the bottom of the baby unit with a narrow pointed object such as a pencil. The ON/OFF light flashes quickly.

When pairing is successful, the screen displays the view of newly paired baby unit in **SINGLE-CAM** mode. The ON/OFF light on the new baby unit remains on.

NOTES

- If pairing fails, the screen displays **Pairing failed.** Try the pairing process again.
- Only one baby unit can be paired at a time.

Positioning the baby monitor

CAUTION

- Keep the baby units out of the reach of your baby. Never place or mount the baby units inside the baby's crib or playpen.

NOTE

- To avoid interference from other electronic devices, place your baby monitor far away from devices such as wireless routers, microwaves, cell phones and computers.

- Place the baby units more than 1 meter (3 feet) away from your baby.

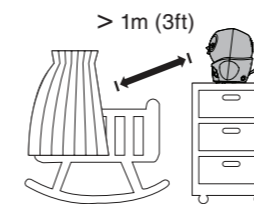

- Adjust the angle of the baby unit camera to aim at your baby.

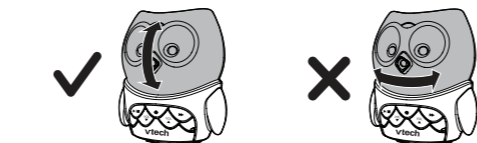

- Place the parent unit more than 1 meter (3 feet) away from the baby units.

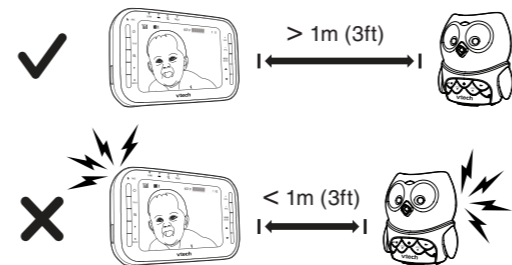

CAUTION

- The default volume of your parent unit is level 4. If you experience high-pitched screeching noise from your baby monitor while positioning:
 - Make sure your baby units and parent unit are more than 1 meter (3 feet) apart, OR
 - Turn down the volume of your parent unit.

Mount the baby monitor (optional)

NOTE

- Check for reception strength and camera angle before drilling the holes.

- Place the wall mount bracket on a wall and then use a pencil to mark the top and the bottom holes as shown. Remove the wall mount bracket and drill two holes in the wall (7/32 inch drill bit).

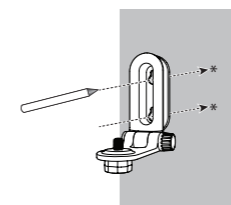

- If you drill the holes into a stud, go to step 3.

-OR-

If you drill the holes into an object other than a stud, insert the wall anchors into the holes. Tap gently on the ends with a hammer until the wall anchors are flush with the wall.



- Align the wall mount bracket and screws with the holes in the wall as shown. Tighten the screw in the middle hole first, so that the wall mount bracket position is fixed. You can tighten the other screw in the top hole.

Place the baby unit on the wall mount bracket. Tighten the screw into the threaded socket at the bottom to secure the baby unit.

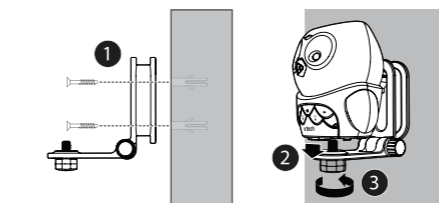

-OR-

Insert the screws into the holes and tighten the screws until only 1/4 inch of the screws are exposed.

Place the baby unit on the wall mount bracket. Tighten the screw into the threaded socket at the bottom to secure the baby unit. Align the holes on the wall mount bracket with the screws on the wall, and slide the wall mount bracket down until it locks into place.

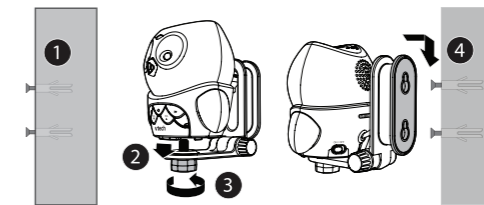

- The default angle of the wall mount bracket is 90 degrees. You can maximize your baby unit's viewing angles by tilting the wall mount bracket.

Hold the baby unit, and then rotate the knob in anticlockwise direction. This will loosen the joint of the wall mount bracket. Tilt your baby unit up or down to adjust to your preferred angle. Then, rotate the knob in clockwise direction to tighten the joint and secure the angle.

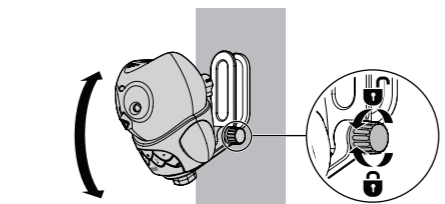

Operating range

The operating range of the baby monitor is up to 300 meters (1,000 feet) outdoors or 50 meters (160 feet) indoors. The actual operating range may vary depending on the environmental conditions and other interferences such as walls, doors and other obstructions.

Unpair a baby unit

NOTE

Make sure you power on the baby unit and the parent unit before unpairing the baby unit.

- Press **MENU** when the parent unit is idle.
- Press ▼ or ▲ to choose **Pair/Unpair CAM**, then press **SELECT**.
- Press ▼ or ▲ to choose **Unpair CAM**, then press **SELECT**.
- Press ▼ or ▲ to choose a desired baby unit, then press **SELECT**.
- The screen displays **To unpair CAM X, press the [ZOOM] key at the Parent Unit..** Press @ on the parent unit.
- The screen displays **Then, press the [MENU/SELECT] key to confirm..** Press **SELECT** to continue.
- When unpairing is successful, the screen displays **CAM X is unpaired** and returns to previous menu. If there is no paired baby unit, the screen displays **No CAM is paired..** The ON/OFF light on the unpaired baby unit flashes slowly.

General product care

To keep this product working well and looking good, follow these guidelines:

- Avoid putting it near heating appliances and devices that generate electrical noise (for example, motors or fluorescent lamps).
- DO NOT expose it to direct sunlight or moisture.
- Avoid dropping the product or treating it roughly.
- Clean with a soft cloth.
- DO NOT immerse the baby unit in water and do not clean them under the tap.
- DO NOT use cleaning spray or liquid cleaners.
- Make sure the baby unit is dry before you connect them to the mains again.

Important safety instructions

When using your equipment, basic safety precautions should always be followed to reduce the risk of fire, electric shock and injury, including the following:

- Follow all warnings and instructions marked on the product.
- Adult setup is required.
- This product is intended as an aid. It is not a substitute for responsible and proper adult supervision and should not be used as such.
- This product is not intended for use as a medical monitor.
- Do not use this product near water. For example, do not use it next to a bath tub, wash bowl, kitchen sink, laundry tub or swimming pool, or in a wet basement or shower.
- Use only the adapters included with this product. Incorrect adapter polarity or voltage can seriously damage the product. Baby unit power adapter: Output: 5V DC 1A
- The power adapters are intended to be correctly oriented in a vertical or floor mount position. The prongs are not designed to hold the plug in place if it is plugged into a ceiling, under-the-table or cabinet outlet.
- For pluggable equipment, the socket-outlet shall be installed near the equipment and shall be easily accessible.
- Unplug this product from the wall outlet before cleaning. Do not use liquid or aerosol cleaners. Use a damp cloth for cleaning.
- Do not cut off the power adapters to replace them with other plugs, as this causes a hazardous situation.
- Do not allow anything to rest on the power cords. Do not install this product where the cords may be walked on or crimped.
- This product should be operated only from the type of power source indicated on the marking label. If you are not sure of the type of power supply in your home, consult your dealer or local power company.
- Do not overload wall outlets or use an extension cord.
- Do not place this product on an unstable table, shelf, stand or other unstable surfaces.
- This product should not be placed in any area where proper ventilation is not provided. Slots and openings in the back or bottom of this product are provided for ventilation. To protect them from overheating, these openings must not be blocked by placing the product on a soft surface such as a bed, sofa or rug. This product should never be placed near or over a radiator or heat register.

- Never push objects of any kind into this product through the slots because they may touch dangerous voltage points or create a short circuit. Never spill liquid of any kind on the product.
- To reduce the risk of electric shock, do not disassemble this product, but take it to an authorized service facility. Opening or removing parts of the product other than specified access doors may expose you to dangerous voltages or other risks. Incorrect reassembling can cause electric shock when the product is subsequently used.

- You should test the sound reception every time you turn on the units or move one of the components.
- Periodically examine all components for damage.
- Be aware of possible loss of privacy while using public airwaves. Conversations may be picked up by other nursery monitors, cordless phones, scanners, etc.

- Children should be supervised to ensure that they do not play with the product.
- The product is not intended for use by persons (including children) with reduced physical, sensory or mental capabilities, or lack of experience and knowledge, unless they have been given supervision or instruction concerning use of the appliance by a person responsible for their safety.

SAVE THESE INSTRUCTIONS

Cautions

- Use and store the product at a temperature between 32°F and 104°F.
- Do not expose the product to extreme cold, heat or direct sunlight. Do not put the product close to a heating source.
- Make sure the baby unit(s) and the adapter cord(s) are always out of reach of the baby, at least 3 feet away from the baby or crib, to avoid a possible strangulation hazard.
- Never place the baby unit(s) inside the baby's crib or playpen. Never cover the baby unit(s) with anything such as a towel or a blanket.
- Other electronic products may cause interference with your baby monitor. Try installing your baby monitor as far away from these electronic devices as possible: wireless routers, radios, cellular telephones, intercoms, room monitors, televisions, personal computers, kitchen appliances and cordless telephones.

Precautions for users of implanted cardiac pacemakers

Cardiac pacemakers (applies only to digital cordless devices):

Wireless Technology Research, LLC (WTR), an independent research entity, led a multidisciplinary evaluation of the interference between portable wireless devices and implanted cardiac pacemakers. Supported by the U.S. Food and Drug Administration, WTR recommends to physicians that:

Pacemaker patients

- Should keep wireless devices at least six inches from the pacemaker.
- Should NOT place wireless devices directly over the pacemaker, such as in a breast pocket, when it is turned ON.

WTR's evaluation did not identify any risk to bystanders with pacemakers from other persons using wireless devices.

Electromagnetic fields (EMF)

This VTech product complies with all standards regarding electromagnetic fields (EMF). If handled properly and according to the instructions in this user's manual, the product is safe to be used based on scientific evidence available today.

The RBRC® seal

The RBRC® seal on the lithium-ion battery indicates that VTech Communications, Inc. is voluntarily participating in an industry program to collect and recycle these batteries at the end of their useful lives, when taken out of service within the United States and Canada.

The RBRC® program provides a convenient alternative to placing used lithium-ion batteries into the trash or municipal waste, which may be illegal in your area.

VTech's participation in RBRC® makes it easy for you to drop off the spent battery at local retailers participating in the RBRC® program or at authorized VTech product service centers. Please call **1 (800) 8 BATTERY®** for information on Li-ion battery recycling and disposal bans/restrictions in your area. VTech's involvement in this program is part of its commitment to protecting our environment and conserving natural resources.



RBRC® and 1 (800) 8 BATTERY® are registered trademarks of the Rechargeable Battery Recycling Corporation.

FCC and IC regulations

FCC Part 15

This equipment has been tested and found to comply with the requirements for a Class B digital device under Part 15 of the Federal Communications Commission (FCC) rules. These requirements are intended to provide reasonable protection against harmful interference in a residential installation. This equipment generates, uses and can radiate radio frequency energy and, if not installed and used in accordance with the instructions, may cause harmful interference to radio communications. However, there is no guarantee that interference will not occur in a particular installation. If this equipment does cause harmful interference to radio or television reception, which can be determined by turning the equipment off and on, the user is encouraged to try to correct the interference by one or more of the following measures:

- Reorient or relocate the receiving antenna.
- Increase the separation between the equipment and receiver.
- Connect the equipment into an outlet on a circuit different from that to which the receiver is connected.
- Consult the dealer or an experienced radio/TV technician for help.

WARNING: Changes or modifications to this equipment not expressly approved by the party responsible for compliance could void the user's authority to operate the equipment.

This device complies with Part 15 of the FCC rules. Operation is subject to the following two conditions: (1) this device may not cause harmful interference, and (2) this device must accept any interference received, including interference that may cause undesired operation.

To ensure safety of users, the FCC has established criteria for the amount of radio frequency energy that can be safely absorbed by a user or bystander according to the intended usage of the product. This product has been tested and found to comply with the FCC criteria. The baby unit shall be installed and used such that parts of all persons' body are maintained at a distance of approximately 8 in (20 cm) or more.

This Class B digital apparatus complies with Canadian requirement:
CAN ICES-3 (B)/NMB-3(B)

Industry Canada

This device complies with Industry Canada licence-exempt RSS standard(s).

Operation is subject to the following two conditions: (1) this device may not cause harmful interference, and (2) this device must accept any interference, including interference that may cause undesired operation.

The term "IC:" before the certification/registration number only signifies that the Industry Canada technical specifications were met.

This product meets the applicable Industry Canada technical specifications.

RF radiation exposure statement

The baby unit complies with FCC RF radiation exposure limits set forth for an uncontrolled environment. The baby unit should be installed and operated with a minimum distance of 8 in (20 cm) between the baby unit and all persons' body. Use of other accessories may not ensure compliance with FCC RF exposure guidelines. This transmitter must not be co-located or operating in conjunction with any other antenna or transmitter. This equipment complies also with Industry Canada RSS-102 with respect to Canada's Health Code 6 for Exposure of Humans to RF Fields.

For cETL compliance only

Mesures de sécurité importantes

Lorsque vous utilisez votre appareil, vous devriez toujours suivre certaines mesures de précaution de base afin de réduire les risques d'incendie, d'électrocution et de blessures corporelles, dont ceux qui suivent :

- Observez toutes les instructions et mises en garde inscrites sur l'appareil.
- L'installation par un adulte est requise.
- Ce produit a été conçu pour être un dispositif d'appoint seulement. Il n'est pas le remplacement d'une supervision responsable et adéquate par un adulte et ne devrait pas être utilisé comme telle.
- Ce produit n'est pas conçu pour être utilisé en tant que moniteur médical.
- N'utilisez pas cet appareil près de l'eau ni de toute autre source d'humidité, par exemple, près d'une baignoire, cuve à lessive, évier de cuisine, dans un sous-sol humide ni près d'une piscine, dans un soussol humide ou une douche.
- N'utilisez que les adaptateurs inclus avec ce produit. L'utilisation d'un adaptateur dont la polarité ou la tension serait inadéquate risque d'endommager sérieusement le produit et mettre votre sécurité en péril.
Adaptateur de l'unité du bébé : 5 V CC 1A

dangereux ou d'autres dangers. Un remontage incorrect peut par la suite présenter des risques d'électrocution.

- Vous devriez tester la réception chaque fois que vous mettez l'appareil en fonction.
- Lorsqu'ils sont branchés dans une prise de courant, les adaptateurs secteur ont été conçus pour être orientés correctement, soit à la verticale ou au plancher. Les broches n'ont pas été conçues pour supporter le poids du bloc d'alimentation et le maintenir en place si celui-ci est branché dans une prise au plafond, sous une table ou dans un meuble.
- Débranchez ce produit de la prise de courant avant de procéder au nettoyage. N'utilisez pas de nettoyants en aérosols. Utilisez un chiffon humide pour le nettoyer.
- Ne coupez pas les cordons d'alimentation pour remplacer les fiches, car ceci peut présenter un danger potentiel.
- Ne laissez aucun objet reposer ni appuyer sur le cordon d'alimentation. N'installez pas cet appareil dans un endroit où l'on risque d'écraser le cordon d'alimentation ou de le piétiner.
- Ne faites fonctionner cet appareil qu'avec le type d'alimentation indiqué sur l'étiquette. Si vous ne connaissez pas le type d'alimentation que vous possédez à votre domicile, consultez votre marchand ou votre compagnie locale d'électricité.
- Ne surchargez pas les prises de courant murales ni les rallonges électriques.
- Ne placez pas cet appareil sur un chariot, meuble, trépid, support de montage ni table chancelants.
- Les trous et ouvertures du boîtier, situés à l'arrière de l'appareil ou sous celui-ci, servent à aérer l'appareil. Pour l'empêcher de surchauffer, ne bloquez sous aucun prétexte ces ouvertures et n'empêchez pas l'aération adéquate de l'appareil en le plaçant sur un lit, divan, tapis ou toute autre surface similaire. De même, ne le positionnez pas à proximité ni au-dessus d'une source de chaleur ou d'un calorifère. De plus, ne placez pas l'appareil dans un endroit avant de vous assurer qu'il y ait une bonne circulation d'air.
- N'enfoncez jamais d'objets à travers les ouvertures de cet appareil, car ils pourraient entrer en contact avec des points de tension dangereux ou causer des courts-circuits qui peuvent dégénérer en incendies ou en risques d'électrocution. Ne renversez jamais de liquide dans ce produit.
- Afin de réduire les risques d'électrocution, ne démontez pas cet appareil, mais apportez-le dans un centre de service autorisé. L'ouverture du boîtier ou le retrait de toutes pièces que contient cet appareil, à l'exception de l'accès autorisé à certaines portes ou ouvertures, risque de vous exposer à des points de tension

Stimulateurs cardiaques implantés dans l'organisme

Les stimulateurs cardiaques (ne s'applique qu'aux dispositifs numériques sans fil) :

L'organisme 'Wireless Technology Research, LLC (WTR)', une firme de recherche indépendante, a mené une évaluation pluridisciplinaire des interférences entre les téléphones sans fil portatifs et les stimulateurs cardiaques implantés dans l'organisme. Appuyée par l'Administration des aliments et drogues (FDA) des États-Unis, la firme WTR recommande aux médecins:

Avis aux détenteurs de stimulateurs cardiaques

- Vous devriez maintenir les dispositifs sans fil à au moins six pouces du simulateur cardiaque.
- Ils ne doivent PAS placer le téléphone sans fil directement sur le stimulateur cardiaque, tel que dans une poche de chemise, lorsque celui-ci est en marche.

L'étude effectuée par l'organisme WRS n'a pas identifié de risque pour les détenteurs de stimulateurs cardiaques causés par les gens qui utilisent dispositifs sans fil à proximité de ceux-ci.

CONSERVEZ CES INSTRUCTIONS

Mises en garde

- Utilisez et entreposez le produit à une température entre 0° C (32°F) et 40° C (104° F).
- N'exposez pas cet appareil à des froids ou des chaleurs extrêmes, ainsi qu'à la lumière directe du soleil. Ne l'installez pas près d'une source de chauffage.
- Assurez-vous que le moniteur et le cordon de l'adaptateur sont toujours hors de portée des enfants, à au moins 1 mètre (3 pieds) de l'enfant ou du berceau, pour éviter tout risque de strangulation.
- Ne jamais placer le moniteur à l'intérieur du berceau ou du parc de bébé. Ne jamais couvrir le moniteur ou l'unité (s) portative avec un article tel une serviette ou une couverture.
- D'autres équipements électroniques peuvent produire des interférences sur votre moniteur vidéo et audio. Tentez d'installer votre moniteur vidéo ou audio à l'écart des appareils électroniques tels que des routeurs sans fil, radios, téléphones cellulaires, interphones, moniteurs, téléphones, ordinateurs personnels, électroménagers et téléphones sans fil.

Champs électromagnétiques (EMF)

Ce produit de VTech est conforme à toutes les normes se rapportant aux champs électromagnétiques (EMF) standard. Si vous le manipulez correctement en suivant les instructions de ce guide, son utilisation sera sécuritaire pendant de nombreuses années, selon les meilleures évidences scientifiques dont nous disposons aujourd'hui.

Limited warranty

What does this limited warranty cover?

The manufacturer of this VTech Product warrants to the holder of a valid proof of purchase ("Consumer" or "you") that the Product and all accessories provided in the sales package ("Product") are free from defects in material and workmanship, pursuant to the following terms and conditions, when installed and used normally and in accordance with the Product operating instructions. This limited warranty extends only to the Consumer for Products purchased and used in the United States of America and Canada.

What will VTech do if the Product is not free from defects in materials and workmanship during the limited warranty period ("Materially Defective Product")?

During the limited warranty period, VTech's authorized service representative will repair or replace at VTech's option, without charge, a Materially Defective Product. If we repair the Product, we may use new or refurbished replacement parts. If we choose to replace the Product, we may replace it with a new or refurbished Product of the same or similar design. We will retain defective parts, modules, or equipment. Repair or replacement of the Product, at VTech's option, is your exclusive remedy. VTech will return the repaired or replacement Products to you in working condition. You should expect the repair or replacement to take approximately 30 days.

How long is the limited warranty period?

The limited warranty period for the Product extends for ONE (1) YEAR from the date of purchase. If VTech repairs or replaces a Materially Defective Product under the terms of this limited warranty, this limited warranty also applies to the repaired or replacement Product for a period of either (a) 90 days from the date the repaired or replacement Product is shipped to you or (b) the time remaining on the original one-year warranty; whichever is longer.

What is not covered by this limited warranty?

This limited warranty does not cover:

- Product that has been subjected to misuse, accident, shipping or other physical damage, improper installation, abnormal operation or handling, neglect, inundation, fire, water or other liquid intrusion; or
- Product that has been damaged due to repair, alteration or modification by anyone other than an authorized service representative of VTech; or
- Product to the extent that the problem experienced is caused by signal conditions, network reliability, or cable or antenna systems; or
- Product to the extent that the problem is caused by use with non-VTech accessories; or
- Product whose warranty/quality stickers, product serial number plates or electronic serial numbers have been removed, altered or rendered illegible; or
- Product purchased, used, serviced, or shipped for repair from outside the United States of America or Canada, or used for commercial or institutional purposes (including but not limited to Products used for rental purposes); or
- Product returned without a valid proof of purchase (see item 2 on the next page); or
- Charges for installation or set up, adjustment of customer controls, and installation or repair of systems outside the unit.

How do you get warranty service?

To obtain warranty service in the USA, please visit our website at www.vtechphones.com or call 1 (800) 595-9511. In Canada, go to www.vtechcanada.com or call 1 (800) 267-7377.

NOTE: Before calling for service, please review the user's manual - a check of the Product's controls and features may save you a service call.

Except as provided by applicable law, you assume the risk of loss or damage during transit and transportation and are responsible for delivery or handling charges incurred in the transport of the Product(s) to the service location. VTech will return repaired or replaced Product under this limited warranty. Transportation, delivery or handling charges are prepaid. VTech assumes no risk for damage or loss of the Product in transit. If the Product failure is not covered by this limited warranty, or proof of purchase does not meet the terms of this limited warranty, VTech will notify you and will request that you authorize the cost of repair prior to any further repair activity. You must pay for the cost of repair and return shipping costs for the repair of Products that are not covered by this limited warranty.

What must you return with the Product to get warranty service?

- Return the entire original package and contents including the Product to the VTech service location along with a description of the malfunction or difficulty; and
- Include a "valid proof of purchase" (sales receipt) identifying the Product purchased (Product model) and the date of purchase or receipt; and
- Provide your name, complete and correct mailing address, and telephone number.

Other limitations

This warranty is the complete and exclusive agreement between you and VTech. It supersedes all other written or oral communications related to this Product. VTech provides no other warranties for this Product. The warranty exclusively describes all of VTech's responsibilities regarding the Product. There are no other express warranties. No one is authorized to make modifications to this limited warranty and you should not rely on any such modification.

State/Provincial Law Rights: This warranty gives you specific legal rights, and you may also have other rights, which vary from state to state or province to province.

Limitations: Implied warranties, including those of fitness for a particular purpose and merchantability (an unwritten warranty that the Product is fit for ordinary use) are limited to one year from the date of purchase. Some states/provinces do not allow limitations on how long an implied warranty lasts, so the above limitation may not apply to you. In no event shall VTech be liable for any indirect, special, incidental, consequential, or similar damages

(including, but not limited to lost profits or revenue, inability to use the Product or other associated equipment, the cost of substitute equipment, and claims by third parties) resulting from the use of this Product. Some states/provinces do not allow the exclusion or limitation of incidental or consequential damages, so the above limitation or exclusion may not apply to you.

Please retain your original sales receipt as proof of purchase.

Technical specifications

Frequency control	Crystal controlled PLL synthesizer
Transmit frequency	2406 - 2475 MHz
Channels	24
Nominal effective range	Maximum power allowed by FCC and IC. Actual operating range may vary according to environmental conditions at the time of use.
Power requirements	Output: 5V DC @ 1A

Credits:

The *Background Noise* sound file was created by Caroline Ford, and is used under the Creative Commons license.

The *Stream Noise* sound file was created by Caroline Ford, and is used under the Creative Commons license.

The *Crickets At Night* sound file was created by Mike Koenig, and is used under the Creative Commons license.

The *Heart Beat* sound file was created by Zarabadeu, and is used under the Creative Commons license.



Specifications are subject to change without notice.
© 2016 VTech Communications, Inc.
All rights reserved. 08/16. VM315-X_CIB_V2
Document order number: 91-010276-010-100